



# Installation Instructions

## Pre-finished Engineered Hardwood



# Attention

Before starting installation, read all instructions thoroughly. Should any questions arise, please contact your local Hallmark Floors dealer. Instructions available at [www.hallmarkfloors.com](http://www.hallmarkfloors.com). Instructions also available via cell phone. All installation instructions must be followed for warranties to be considered valid. Pre-inspect the job site prior to delivery of the floor to ensure the structure is suitable for hardwood flooring installation using the following guidelines:

## Owner/Installer Responsibility

1. Inspect the hardwood flooring in well lighted conditions to ensure proper identification of any potential problems. Carefully inspect the flooring for grade, color, finish, and quality. Material that is subjectively viewed as unacceptable but falls within Hallmark Floors grading norms will not be replaced. Material with visible defects can be returned for replacement through the dealer.
2. Inspect the hardwood flooring in well lighted conditions to ensure proper identification of any potential problems. Carefully inspect the flooring for grade, (see Hallmark Floors grading standards at [www.hallmarkfloors.com](http://www.hallmarkfloors.com)) for color, finish, and quality. If the flooring is not acceptable, contact Hallmark Hardwoods and arrange shipment of replacement material. Defective product will be replaced. Material that is subjectively viewed as unacceptable but falls within Hallmark Floors' grading norms will not be replaced.
3. Prior to installation of any flooring, the installer must ensure the job site and sub-floor conditions meet the requirements specified in these instructions.
4. Hardwood flooring installation should be one of the last items completed on the construction project. Limit foot traffic on the finished wood floor.

## Grading Standards

### General Rules:

Flooring shall be tongue and grooved and end matched (unless otherwise indicated). Flooring shall not be considered of standard grade unless properly dried. The drying standard for Hallmark product shall be 8 to 10% moisture content by volume with a plus or minus factor of 2% for storage conditions in various climate zones.

### Grading Rules:

Hallmark Floors, like many flooring and lumber mills, uses a proprietary grade for manufacturing our floors. Proprietary grades are generally referred to as Mill Run. Instead of separating the lumber into traditional NOFMA/NWFA grades, the flooring is a mix of grades. This enables Hallmark to produce wider and longer boards. Hallmark grading rules allow for filled knots, mineral streak, open checks, tight checks, and filled checks. Bird peck, pin worm hole, and flag worm hole are acceptable (any insects are killed in drying process). Plank faces may also contain unlimited amounts of heart wood (dark portion of log) and/or sap wood (light portion of log).

*NOTE: Organic Engineered 567 is textured prior to drying to achieve the true look of reclaimed. As such, the edges will have height variations, just like material reclaimed from an old building. Over and under, or height variation from plank to plank, is an inherent part of the rough sawn nature of reclaimed, which Hallmark Floors emulates in our manufacturing process. This is not considered to be a defect.*

# Environmental Issues

Damage caused by inappropriate handling, environment, installation, or maintenance issues will not be considered in relationship to grade.

## Storage and Handling

Handle and unload wood flooring with care. Store in a dry place; Make sure to provide at least a four-inch space (using dry 4" x 4" stickers or a dry pallet that provides enough clearance under boxes for proper air movement. Prior to delivery of flooring, outside doors and windows must be in place.

All concrete, masonry, plastering, and other "wet" work must be complete and thoroughly dry prior to flooring installation. Roofing and the exterior shell of the structure must be finished and weather tight with doors and windows installed. The wall coverings should be in place and all painting completed—except for the final coat on the base molding. Room temperature and humidity should be consistent with year round conditions for at least one week prior to installation. When possible, install base molding after floor installation is complete.

HVAC MUST BE RUNNING WITH A ROOM TEMPERATURE OF BETWEEN 60°F TO 80°F AND RELATIVE HUMIDITY OF BETWEEN 30 AND 55%.

*NOTE: See Hallmark Healthy Home for greater detail on how proper humidity ranges can be maintained.*

## California Prop 65 Warning

Drilling, cutting, and grinding of concrete generates concrete dust, containing crystalline silica, a substance known to the State of California to cause cancer, birth defects, or other reproductive harm. Avoid inhaling concrete dust by wearing a dust mask or other safeguards for personal protection. CA HEALTH AND SAFETY CODE 14808-60-7: Wear appropriate NIOSH designated dust mask to reduce risk of dust inhalation. Wear proper eye protection and avoid prolonged contact with eyes and skin. In the event of eye irritation, flush with water for 15 minutes and seek medical attention!

## Pre-Installation Inspection

### VISUAL INSPECTION

The first inspection is visual and basic. Is there water in the building? Are the doors and windows installed and the building weather tight?

### CLIMATE CONTROL

If heating and/or air conditioning with proper humidity controls are in operating condition, they need to be turned on. If it is not possible for the permanent system to operate, a temporary system that provides proper temperature and humidity conditions must be in place and remain in place until permanent climate control is operational.

### INSTALL FLOORING LAST

Hardwood floor should be the last trade in the house (before base boards are installed). All concrete, masonry, plastering/drywall, texturing, and painting/primer coats should be completed beforehand. Covering the floor while wet trades are in the house can lead to moisture condensation on the protective paper. Moisture can pull into the paper or be trapped under the surface of materials used to cover the floor. Paper coverings also allow dents and scratching to occur. Coverings held in place for more than 24 hours by blue tape can damage the floor. The adhesive in tapes contain Phthalates /plasticizers that have the ability to penetrate floor finishes and bond with the finish at the molecular level presenting a risk of pulling/damaging the finish when the tape is removed. Hallmark recommends that built in cabinets and built in furniture be installed before installation of the floor. This prevents damage to the flooring, making any potential flooring repairs simpler to perform.

## Exterior Checks

1. Is exterior soil elevation 6" below edge of flashing?
2. Does exterior slope away from foundation at a rate of 6" drop in 10' for soft-landscaped areas and 3" drop in 10' for hard-paved areas?

*NOTE: Proper drainage away from the structure is absolutely critical to ensure weather-tight conditions and crucial to proper hardwood flooring performance. If structure is near a hill, the lot should be graded with a swale to move moisture off the lot and prevent it from coming in contact with the foundation.*

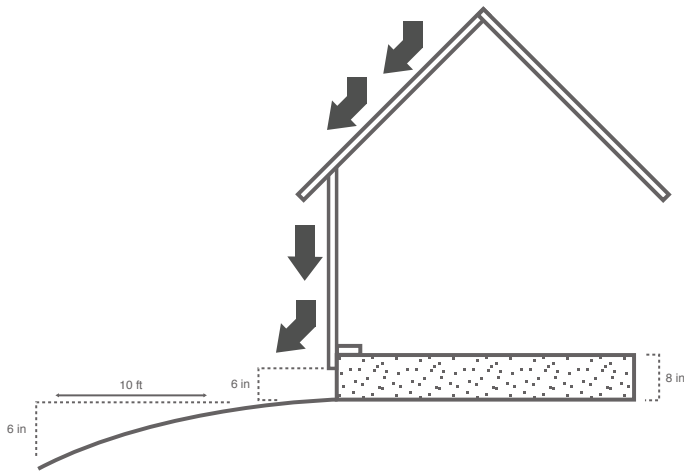

## Crawl Space Ventilation

Crawl space earth (or thin concrete slab) should be covered 100% by a vapor retarder of black polyethylene (minimum 6 mil) or any recommended puncture-resistant membrane, such as Class C meeting ASTM D1745. Check local codes for any additional requirements.

Size of available vents should equal to 1.5% of the square footage within the crawl space. Relative humidity should be consistent with interior of home. Moisture content of sub floor should not vary more than a 2% MC from the top of the sub floor to the bottom.

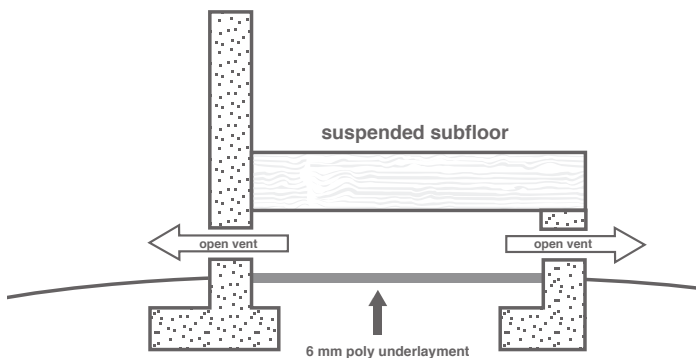

It may be necessary to install temperature/humidity activated exhaust fans to create more air movement in the crawl space. Uncontrolled humidity and moisture in crawl space will lead to mold and damage to the structure, as well as the hardwood floor. In these events, a contractor specializing in dehumidifying systems will need to be contracted to keep crawlspace humidity within proper norms. This is more likely in high humidity areas.

Ensure that clothes driers are properly vented to the outside of the foundation. Check for signs of plumbing, both pressurized and non-pressurized/drain leaks.



*NOTE: Completely sealed crawlspace (no exterior cross-ventilation) require a dehumidification system as part of the sealed crawlspace design.*

## Basement Moisture & Humidity Control

Basements should be completely weather tight and have proper drainage away from the foundation walls in place to ensure that the basement remains dry.

1. Rain gutters must be in place to carry moisture away from the house. French drains are recommended, and basement walls should be properly sealed.
2. Relative humidity of basements should not be more than 10% higher than the upper floors.
3. Humidity control of the basement is vital to help control mold and prevent damage to the structure and hardwood flooring.
4. Basement walls should be inspected for cracks and excessive moisture content.
5. Drains must be placed at basement windows.
6. Direct sprinklers and irrigation systems away from the foundation. Sprinklers spraying the foundation edge can lead to moisture intrusion into structure. Drip irrigation systems for plant beds is recommended.

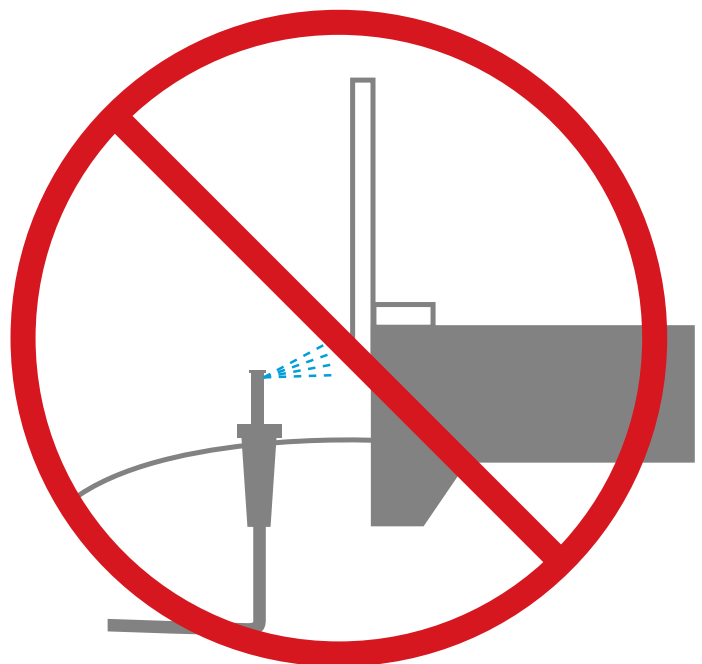

## Sub floor Moisture Testing CONCRETE

Since wood flooring is not compatible with wet conditions, Hallmark Floors does not warrant against moisture related issues or related damage under warranty. (See Hallmark Floors Maintenance & Warranty Guides). This is an industry standard, and manufacturers do not offer moisture warranties. However, moisture warranties are offered by various adhesive manufactures.

*NOTE: Due to the porous nature of concrete, vapor emissions are subject to change over the lifetime of the installed floor. Slab moisture emissions are a common cause of damage to hardwood floors. Due to the potential for concrete moisture emissions to increase/decrease over time, and the absence of moisture warranties for wood flooring, choosing an adhesive system that includes moisture abatement properties is prudent.*

Adhesive manufacturer's offer moisture warranties for moisture abatement systems that will be conditional. Follow their directions closely to ensure compliance and full warranty coverage. Proper spread rate and coverage are very important. Use proper trowel size and replace trowels at the recommended square footage the adhesive manufacturer requires to ensure proper application thickness.

Some adhesive manufacturers offer adhesive/moisture abatement systems that do not require pre-installation testing of the slab to maintain a moisture warranty. Check with adhesive manufacturer to confirm which products they offer, that allow installation without pre-checking/testing the slab.

*ADDITIONAL NOTE: Hallmark Floors makes no guarantees regarding the performance of any adhesive/vapor abatement system.*

The installer is fully responsible for proper installation, and the moisture warranties are fully the responsibility of the adhesive moisture abatement system manufacturer chosen for the job.

## NWFA & Industry Standards

The NWFA (Industry standard) uses the following test methods to determine optimal conditions for installation and performance of a hardwood floor. Some adhesive manufacturers offer systems that create a vapor barrier to protect the wood flooring from moisture emissions coming up through the slab. Many adhesive manufacturers require the tests listed below to be performed prior to installation of the floor. Carefully read and follow the adhesive manufacturer's instructions.

### CALCIUM CHLORIDE: ASTM F1869

Under ideal conditions, the slab should not be emitting more than 3 lbs. per 1,000 square feet per 24 hour period. Carefully follow the instructions in the test kit to ensure that you get accurate results.

*NOTE: The slab emissions can vary based on soil humidity and room temperature. Consult adhesive manufacturer's directions for the moisture abatement system they recommend.*

### HUMIDITY PROBE & DIGITAL METER: ASTM F2170

Widely used in Europe, this test determines the amount of humidity in the slab. This is an effective way to determine a slab's potential for emitting moisture. Follow all meter manufacturer's guidelines for performing testing. Under ideal conditions, the slab readings should be 75% RH.

*CAUTION: Post Tension slabs require special care to avoid cutting cables in slab. Cutting post tension cables can cause serious structural damage and potential fatalities.*

New concrete slabs require a minimum of 60 days drying time before covering them with a wood floor. The slab must be fully cured. Slab must be comprised of Portland-based mix with 2,500 PSI of compressive strength.

## Sub floor Preparation CONCRETE

For glue down application over gypsum or lightweight concrete, the same 2,500 PSI rating is required. (See floating installation section for installation over lightweight substrates).

*Note: Some adhesive systems have primers and adhesives that are suitable for use over gypcrete or lightweight concrete, and may have different PSI compressive strength requirements. Adhesive manufacturer is responsible for performance of their systems over gypcrete or lightweight concrete.*

Remove all paint, oil, existing adhesives, wax, grease, dirt, sealers, and curing compounds. Do not use solvent-based strippers under any circumstances, as residual solvents can prevent the satisfactory bonding of the vapor barrier and adhesive systems. It is important to ensure a long-lasting bond between the adhesive, the concrete, and the boards. FOLLOW ALL ADHESIVE APPLICATION INSTRUCTIONS.

Industry standard practice is to use a sanding system with 20 grit # 3½ open-face paper to remove loose, flaky concrete. For heavy surface contamination, it may be necessary to bead blast the concrete surface.

*NOTE: Adhesive manufacturers generally recommend prep fillers and patches to repair concrete substrates that are compatible with the adhesive system to be used. Make sure you use the prep products that are recommended by the adhesive manufacturer.*

Sub floor tolerance for a flat surface is 3/16" within a 10' radius and 1/8" in a 6' radius. These are industry standards established by NWFA. Use a straight edge to determine if sub-floor requires grinding or filling.

*NOTE: A quarter is approximately 1/16" thick and can be used as a thickness gauge. Grind high spots and fill low spots with adhesive manufacturer's recommended filler.*

*NOTE: Use the filler recommended by the adhesive manufacturer.*

### CAUTION: ASBESTOS

*State and Federal agencies have determined that asbestos is a respiratory carcinogen. Avoid sanding or scraping of old vinyl, linoleum and VCT as they may contain asbestos. Take proper precautions and contact an asbestos abatement company to remove any old vinyl or vinyl tile floors containing asbestos. Cut-back adhesive and other types of adhesives can also contain asbestos.*

## Clean the Sub floor

After all prep work is completed, sweep and/or vacuum the sub floor. Dust and dirt can affect the adhesive or vapor barrier's ability to adhere to the slab.



## Installing over Existing Floor Coverings on Concrete

Perimeter-glued resilient vinyl, VCT and rubber tiles are not acceptable underlayments and must be removed.

Terrazzo, tile, and full spread glue-down vinyls that are dry, structurally sound, and level (as described above) may be suitable as a sub floor for installation. See adhesive manufacturer's guidelines. *Hallmark is not responsible for performance or suitability of existing flooring products that are not removed from concrete.*

As indicated above, the surface must be sound, tight, and free of paint, oil, existing adhesives, wax, grease and dirt.

Terrazzo and ceramic tile must be sufficiently scuffed to assure adhesion. Portland based products must be used to comply with flatness requirements of 3/16" in a 10' radius or 1/8" in a 6' radius. See adhesive manufacturer's guidelines.

Existing vinyl, tile, or terrazzo are not considered to be vapor barriers, and can still transmit unacceptable moisture levels to hardwood flooring. Existing hardwood flooring must be removed prior to the installation of a new wood floor on concrete.

## Sub floor Moisture Testing wood

Probe-type (pin) meters are considered the best method of testing.

*Remember: the top and bottom of the sub floor should vary no more than 2%. Wood substrates must have a moisture reading of no more than 12% when using Lignomat, Tramax, Delmhorst, or equivalent moisture meter, and be within 4% of the moisture content of the flooring to be installed*

## Sub floor Preparation wood

Wood sub floors need to be well nailed or secured with screws. Nails should be ring shanks, and screws must be counter-sunk. The wood sub floor needs to be structurally sound (i.e. without loose boards, vinyl, or tiles). Sub floor tolerance for a flat surface is 3/16" within a 10' radius and 1/8" in a 6' radius. These are industry standards established by NWFA.

Engineered sub floor panels, must be ANSI-rated plywood, OSB (oriented strand board) of specified thickness to meet joist spacing specifications listed below, or sound solid lumber sub floor that is a minimum of 3/4" thick and dry.

1. For panel products sub flooring, check for loose panels and re-nail or screw down loose panels securely. Nails and screws must be countersunk.
2. Ensure that there is proper expansion space (1/8") between the panels. If panels are not tongue and groove and do not have sufficient expansion space, it may be necessary use a circular saw to create the specified space. *Do not saw through joints on tongue and groove sub floors.*
3. Check for delamination or damaged areas to sub floor and repair those areas as needed.
4. Make sure sub floor is free of debris before beginning installation.
5. Acceptable Panel Sub floors: Truss/joist spacing will determine the minimum acceptable thickness of the panel sub flooring.
  - a. Truss/joist spacing of 16" (406cm) o/c or less, the industry standard for single panel sub flooring is a minimum of 5/8" (19/32", 15.1mm) CD Exposure 1 plywood sub floor panels or 23/32" OSB Exposure 1 sub floor panels, 4' x 8' panels.
  - b. Truss/joist spacing of more than 16", up to 19.2" (488mm) o/c, the standard is a minimum 3/4" (23/32", 18.3mm) tongue and groove CD Exposure 1 Plywood 4' x 8' sheets glued and mechanically fastened.
  - c. Truss/joist spacing of more than 19.2" (488mm) o/c up to a maximum of 24" (610mm) requires a minimum 7/8" tongue and groove CD Exposure 1 plywood sub floor panels, 4' x 8' sheets, glued and mechanically fastened, or nominal 1" OSB Exposure 1 sub floor panels glued and mechanically fastened—or two layers of sub flooring.

## JOIST CROSS-BRACING

A sub floor that is not thick enough to support the span of the joists will cause unacceptable sub floor deflection. An alternative to adding additional plywood on top of the sub floor would be to cross-brace between the joists. The cross-bracing would be done at the appropriate distance on center to meet specification and bring the deflection within proper tolerance.

Check with the joist or truss manufacturer to determine if cross-bracing is allowed with that system. Should it not be compatible with the joist or truss manufacturer, sheeting the sub floor with a second layer of CD or better grade plywood would then be the only option. (See double layer sub floors section).

## DIRECTION OF INSTALLATION IN RELATION TO JOIST DIRECTION.

The best application is at a 90° angle across the joists. This provides for best stability of the floor. As an alternative, the floor can be installed at a 45° angle to the joists. The floor cannot be installed in the same direction as the joists without installing an additional sheet of plywood on top of the existing wood sub floor.

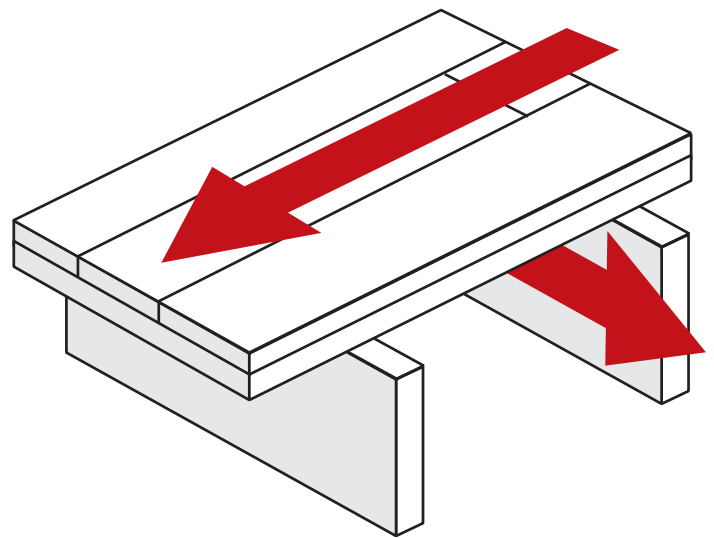

## DOUBLE LAYER SUB FLOORS

When sub floor does not meet thickness standards for span between joists, a second layer of plywood or OSB is required to stiffen sub floor. See item C of previous section.

The second layer should consist of nominal 1/2" (15/32", 11.9mm) CD exposure 1 plywood sub floor panels, 4' x 8' sheets, depending on how much correction of deflection between joists is necessary.

The top layer of plywood should be offset by 2' from joints in first layer of sub floor, and installed in the opposite direction to the bottom sub floor panels. Glue top and bottom layer together with construction adhesive and screwing in to the truss/ joist system every twelve inches. Additionally, nail (ring shank) or staple layers together on a minimum 12" grid pattern.

## EXISTING WOOD FLOOR —ON WOOD SUB FLOOR

When installing over an existing solid hardwood floor already attached to the wood sub floor, ensure that the existing floor is sound and firmly attached to sub floor. Install material at a 90° right angle or 45° angle (across grain) of existing hardwood floor.

*NOTE: Do not install in the same direction as existing floor. Do not install over wood flooring glued to concrete.*

## SOLID BOARD SUB FLOORING

Solid Board Sub flooring should be ¾" x 5 ½" (1" x 6") group 1 dense softwoods (SYP, Doug Fir, Larch, etc.), #2 common, kiln-dried. Solid board sub flooring should consist of boards no wider than 6", installed on a 45° angle, with all board ends full bearing on the joists and fastened with a minimum 8d rosin-coated or ring-shanked nails, or equivalent. Solid board sub flooring that is uneven at the edges should be repaired and sheeted with ½" (15/32", 14mm) CD exposure 1 plywood sub floor panels, 4' x 8' sheets, and should be installed running cross-truss/joist. Glue top and bottom layer together with construction adhesive and screwing into the truss/ joist system every twelve inches. Additionally, nail (ring shank) or staple layers together on a minimum 12" grid pattern.

*GENERAL INFORMATION: No fiberboard or particle board panels acceptable*

*for nail down installation. Underlayment/industrial grade particle board sheeting over existing wooden sub floor is usually suitable for glue down applications. See adhesive manufacturer's specifications to ensure adhesive is suitable for use over underlayment/industrial particle board sheeting. Counter-sink all screws/ nails and sand any uneven edges smooth. High spots should be sanded smooth and low spots shimmed with plywood that is secured to the sub floor and sanded flat.*

## CEMENTITIOUS PATCH - WOOD SUB FLOOR

Do not use cement-based patch to correct any wooden sub floor problems in preparation for nail down. In the event of moisture, determine source, eliminate, and allow sub floor to dry. If sub-floor is less than above specified thickness, or sanded to thickness less than specified see the above standards for top sheeting.

*NOTE: Particle board sheeting of existing wood sub floor and Portland based leveling compounds are acceptable for glue-down or floating applications only (they are NOT suitable for nail-down applications).*

## Acclimation

Wood flooring is a hygroscopic material subject to dimensional change as a result of variations in moisture, temperature, and humidity within the surrounding environment. Wood flooring simply needs to reach a moisture content level in equilibrium with the surrounding environment (EMC) IN WHICH IT WILL BE INSTALLED, AT OR NEAR NORMAL LIVING CONDITIONS (Between 30 –55% RH). The process of reaching this equilibrium is defined as acclimation, which allows the wood to properly adjust itself to the normal living conditions within the structure; that is, the temperature, humidity conditions, and moisture content that will typically be experienced once the structure is occupied and stable indoor climate control is exercised.

*NORMAL ENVIRONMENTAL CONDITIONS MUST BE MET TO ENSURE OPTIMAL PERFORMANCE.*

When heating and ventilating systems are designed and working to maintain an interior relative humidity level between 30% and 55%, and a temperature between 60 and 80°F year round. At manufacturing, flooring is dried to a content of between 8–10% and maintained at a relative humidity environment ranging from 30% to 55%. Ideally, the installation environment will be maintained at the same humidity range.

### ACCLIMATION OF ENGINEERED PRODUCTS

Hallmark manufacturers material to mimic what would be found in a 30–55% relative humidity environment. Consequently, it is pre-acclimated to the green zone conditions found in the chart below.

To maintain proper relative humidity levels, above 30% and below 55% RH, use of the following equipment is recommended. *Failure to maintain humidity range can result in damage to the wood floor.*

Air conditioner (of proper size and in working order)

Dehumidifier (if required) to prevent relative humidity levels above 55%  
Whole House Humidifier (of proper size and in working order) (if required) to maintain relative humidity levels above 30%.

Acclimation is NOT SIMPLY A MATTER OF TIME! It is based on what the living conditions in the house will be. If flooring is acclimated outside of the green zone from the chart above excessive movement and damage to the floor will occur. Check Hallmark Floors Climate Control & Radiant Heat Guide for more details.

*NOTE: The space needs to be acclimated to the engineered wood flooring,*

*more than the other way around. Remember: 30 to 55% RH and 60° to 80°F is the target for indoor conditions.*

### Relative Humidity, Humidity, & EMC Table

From the US Dept. of Agriculture Wood Handbook, Wood as an Engineering Material

Humidity recommendations range from 39% - 50% in a building.

Temperature recommendations range from 60°F - 80°F in a building

If you stay within the recommendations, the amount of expansion and contraction is limited

	Relative Humidity																			
Temp	5	10	15	20	25	30	35	40	45	50	55	60	65	70	75	80	85	90	95	100
30	1.4	2.6	3.7	4.6	5.5	6.3	7.1	7.8	8.7	9.5	10.4	11.3	12.4	13.5	14.9	16.5	18.5	21	24.3	26.9
40	1.4	2.6	3.7	4.6	5.5	6.3	7.1	7.8	8.7	9.5	10.4	11.3	12.4	13.5	14.9	16.5	18.5	21	24.3	26.9
50	1.4	2.6	3.6	4.6	5.5	6.3	7.1	7.9	8.7	9.5	10.3	11.2	12.3	13.4	14.8	16.4	18.4	20.9	24.3	26.9
60	1.3	2.5	3.6	4.6	5.4	6.2	7	7.8	8.6	9.4	10.2	11.1	12.1	13.3	14.6	16.2	18.2	20.7	24.1	26.8
70	1.3	2.5	3.5	4.5	5.4	6.2	6.9	7.7	8.5	9.2	10.1	11	12	13.1	14.4	16	17.9	20.5	23.9	26.6
80	1.3	2.4	3.5	4.4	5.3	6.1	6.8	7.6	8.3	9.1	9.9	10.8	11.7	12.9	14.2	15.7	17.7	20.2	23.6	26.3
90	1.2	2.3	3.4	4.3	5.1	5.9	6.7	7.4	8.1	8.9	9.7	10.5	11.9	12.6	13.9	15.4	17.3	19.8	23.3	26
100	1.2	2.3	3.3	4.2	5	5.8	6.5	7.2	7.9	8.7	9.5	10.3	11.2	12.3	13.6	15.1	17	19.5	22.9	25.6

Example: (red) Conditions in a warehouse are 60% Relative Humidity at 50°F

Dry wood will pick up moisture until 11.2% MC has been reached, regardless of wood species and initial moisture content

## Radiant Heat

Sub floor level tolerances listed previously, also apply to radiant heated sub floors.

ELECTRIC RADIANT HEAT SYSTEMS ARE NOT APPROPRIATE FOR HALLMARK FLOORS.

PASSIVE RADIANT HEAT SYSTEMS ARE NOT SUITABLE FOR THE INSTALLATION OF HALLMARK FLOORS. PASSIVE SYSTEMS DO NOT HAVE THE ABILITY TO MOVE THE AIR OR CONTROL HUMIDITY LEVELS.

*CAUTION: Surface temperature of the wood floor should never exceed 80° F. Temperature sensors must be integrated into system as a fail safe to prevent excessive heat and damage to the hardwood floor.*

*NOTE: Area rugs placed over radiant heat slab will create heat retention in the floor. This may result in that area exceeding optimum temperature, and causing slightly larger gaps and minor cracks/splits in the floor under the rugs.*

### FLOATING INSTALLATION / RADIANT HEAT

Hallmark recommends Eternity Premium Underlayment pad or comparable pad. The tongue and groove must be glued together using White PVA-D3 (poly vinyl acetate) tongue and groove adhesive.

### GLUE DOWN CONCRETE THERMAL MASS / RADIANT HEAT

Adhesive must be approved by adhesive manufacturer for use with radiant heat. Adhesive system must employ a vapor control component designed to be used in conjunction with the adhesive by the adhesive manufacturer.

Thermal mass must be Portland based concrete product and rated at a compressive strength of 2500 psi or greater. Thermal mass with less than 2500 psi compressive strength must use floating installation method unless otherwise specified by adhesive manufacturer. Follow adhesive manufacturers instructions as their psi ratings may be different. Follow all adhesive manufacturer's installation specifications.

Hydronic warm water systems installed in accordance with NWFA specifications are acceptable. Tubing must be a minimum of 1 1/4" below the surface of the concrete thermal mass (no electric matt systems are acceptable). See *Hallmark Healthy Home –Radiant Heat Section* for additional details.

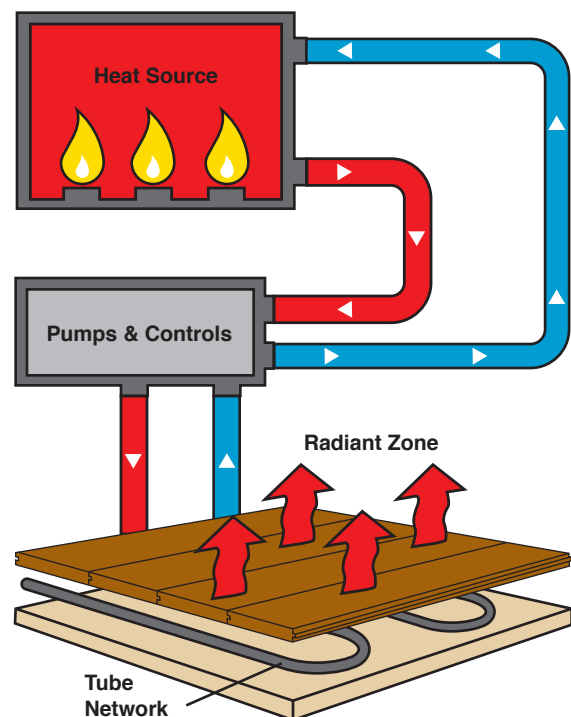

## HYDRONIC SYSTEMS IN A WOOD SUB FLOOR

Assembly must include an aluminum transfer sheet to ensure even distribution of heat. Aluminum tube hanging systems must cover the entire distance between the joists on the bottom of the sub floor.

### RADIANT HEAT APPROVED PRODUCTS

Heirloom: All (excluding Hickory)

Hacienda: All (excluding Hickory)

Moderno: All (excluding Hickory)

Alta Vista: All

Monterey: All (excluding Hickory)

Ventura: All

Chaparral: All (excluding Hickory)

Silverado: All

Novella: All (excluding Hickory)

Organic Engineered: All (excluding Hickory)

*NOTE: Hallmark Solid Hardwood Flooring excluded from Radiant Heat Installation Method.*

### RADIANT HEAT IN LIGHTWEIGHT CONCRETE THERMAL MASS

Two to three weeks prior to the arrival of the hardwood floor and after completion of all wet work at the job site, the radiant heat system should be on at a temperature of 70° F for three weeks and then at 85° F for 2-3 days. During this time, the structure should be well ventilated to prevent moisture buildup (the increased heat is driving the moisture out of the concrete thermal mass during this time). If this is not possible due to weather/ outdoor climate conditions, dehumidifiers should be used to keep moisture from building up in the structure.

*NOTE: Prior to installation, the lightweight concrete moisture content must not exceed 1.5% as measured with a Tramax Moisture Encounter meter. Check adhesive manufacturer's requirements as they may be different.*

### RADIANT HEAT / WOOD SUBSTRUCTURE AND ALUMINUM THERMAL TRANSFER SHEET

Two weeks prior to arrival of hardwood flooring at job site, the radiant heat system should be gradually brought up to 70° F. Moisture levels allowable in wood sub floor are not to exceed 12%. Once systems have reached optimum conditions, Hallmark Floors engineered hardwood flooring should be brought to job site, not before.

### WOOD FLOOR ACCLIMATION PROCESS FOR RADIANT HEAT

Hallmark Floors engineered hardwood flooring is dried to a moisture content of approximately 8% -10% moisture content by volume. This is a stable moisture content, and it is important to adjust the indoor climactic conditions to fully support the moisture content found in the boards. A relative humidity rating of 30 to 55% at time of installation is required.

Allow unopened boxes of Hallmark floors engineered hardwood flooring to stabilize in above environment for 24 to 48 hours to allow material to adjust to room temperature. Room temperature should not vary more than 15° F season to season and relative humidity range between 30% to 55% should be maintained.

*For further information, see Hallmark Floors® Radiant Heat Guide.*

# Below Grade Installation

A concrete slab is considered below grade when any part of the slab is below ground level. For example, a basement with a walk out is considered below grade. A house cut into a hill is also considered to be below grade if it isn't properly graded to create a drainage swale on the lot. Below grade slabs must be carefully tested. Diligently follow all adhesive or underlayment pad manufacturer's instructions for below grade installation. *Nail down installation is not suitable for below grade installation.*

## Getting Started

### 1. Select Installation Type

ABOVE GRADE WOOD SUB FLOOR: Glue, Nail, Float

BASEMENT: Glue with vapor abatement system (follow adhesive manufacturers instructions for below grade installation) Float; follow underlayment pad manufactures instructions for below grade installation. NOTE: No solid installations in basements.

WOOD SUB FLOOR WITH CRAWL SPACE/ BASEMENT: Glue, Nail, Float

ON/ABOVE-GRADE CONCRETE: Glue, Float

ABOVE GRADE LIGHTWEIGHT CONCRETE GYPCRETE: Float, Glue (see adhesive manufactures installation instructions for lightweight concrete/ gypcrete installations

RADIANT HEAT: Float, Glue

*NOTE: Floating systems must use good quality underlayment pad with moisture barrier. If using over radiant heat make sure pad manufacturer authorizes their product for radiant installations.*

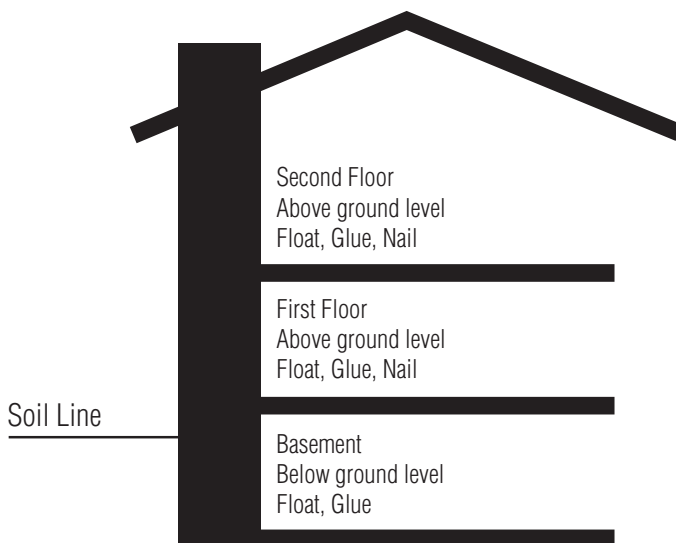

### 2. Cabinets & Appliances

**NAIL DOWN & GLUE DOWN:** Cabinets and built in appliances (sub-zero refrigerators & dishwashers) should be installed prior to the installation of the hardwood floor. Cabinets and built in appliances should not be installed on top of the floor. Installation of cabinets on top of glue or nail down installation does not invalidate warranty. However, since this is not best practice, should the floor require repair under warranty, Hallmark Floors will not be liable for costs to remove and replace cabinets and or counter tops to effect repair.

**FLOATING:** Cabinets and built in appliances should never be installed on top of the floating wood floor. Floating floors require unhindered expansion space in all directions.

Hardwood flooring should be installed at the same time as carpet and after the following: finishing walls, cabinet installation, appliance installation, tile & counter top installation.

Standard refrigerators and kitchen oven/range are acceptable for placement on top of the wood floor. Use caution when moving appliances by using a proper furniture dolly, air sled, 1/8" Masonite with glossy side down, or plastic glides designed for movement of heavy appliances. Failure to follow these precautions will damage the floor.

### 3. Undercut All Door Jamb/Moldings

Remove all shoe and base molding to ensure adequate expansion space. Use scrap piece of flooring to establish height of cut. Make allowances for adhesive or underlayment thickness when establishing height of cut.

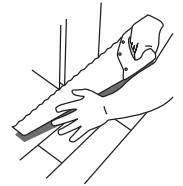

### 4. Visual Inspection of Boards

Visually inspect boards for any defects prior to installation. Verify that homeowner has seen product and approves proceeding with installation of the floor.

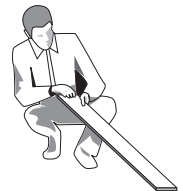

### 5. Open Multiple Boxes

Always work from multiple boxes simultaneously and blend the boards throughout the installation. This is especially important with mixed production dates. Hallmark has very good color consistency, and mixed production dates are acceptable for installation. Working from multiple boxes/production dates helps achieve a good blend of color.

### 6. Blend Boards to Moldings

Before you get started, open multiple boxes and check how the boards blend with the moldings. At beginning of installation, set aside those boards that best blend to the transition moldings on job.

### 7. Select a Starter Wall

It is recommended to start the installation along an exterior wall. Check to make sure the wall is straight and square to the room.



## 8. Starting Line

Cut blocks to use against side and end walls to maintain 1/2" minimum expansion space. Use of adjustable spacers may be needed to help maintain a straight line.

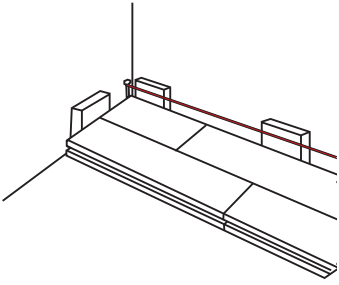

## 9. Irregular & Out-of-Square Walls

Scribe cut the first row to match variations in the wall. A scribe can be created by drilling a hole in a scrap piece of wood and inserting a pencil. The starting row can then be cut to compensate for an irregular wall or to help minimize the appearance of an out of square room by splitting the difference between the two walls.

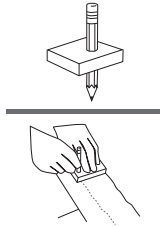

## 10. Establishing End Joint Spacing

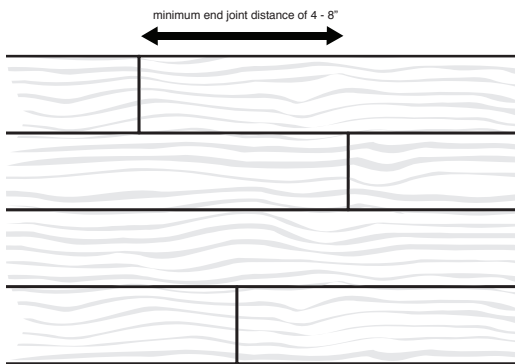

Applicable for all three methods of installation (glue-down, nail down, float). Each box contains random length boards. Use these boards as well as making some random cuts to establish a random pattern. Maintain a minimum distance/stagger between end joints of 4-8".

## 11. Change of Direction

GROOVE TO GROOVE, USING A SLIP TONGUE/WOOD SPLINE:

Slip-tongue/wood-spline can be fabricated using birch plywood, cut into strips on a table saw. Cut width to 5/16" wide to allow room for glue once inserted. The following thickness of Baltic Birch plywood should be used to fabricate wood spline for the following thickness of Hallmark Flooring:

3/8" = 3mm or 1/4"

1/2" = 4mm or 5/32"

7/16" = 3mm or 1/4"

9/16" = 4mm or 5/32"

5/8" = 5mm or 3/16"

3/4" = 6mm or 1/4"

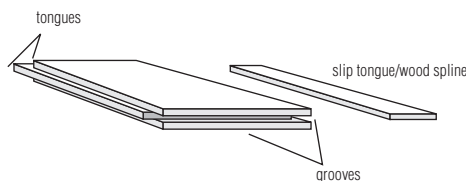

*Note: Sand corners of spline with sanding block and 60 grit sandpaper to soften/round the edges (all four sides).*

## Installation Alert

Do not use rubber mallets or hammers on the finished edge of the floors. Do not kick, the floor into place. Mallets and hammers damage the finished edge and kicking can scratch the floor.

## Glue Down Installation

GENERAL INFORMATION

*NOTE: Follow instructions 1-11 and all directions listed below.*

### Installation Tools GLUE DOWN

Tape measure, pencil, chalk line, table saw, cut-off saw, jamb saw, tapping block, pull bar, spacers, ratcheting floor straps, hammer, safety glasses, hearing protection, utility knife, specified notched trowel, wall spacers, straight edge, broom, speedy square, hardwood floor cleaner, and shop vacuum.

## 12 GD. Remove Tongue & Lead with Groove

Cut off tongue on very first row to be installed and lead with the groove. This enables the tongue to be partially inserted into the groove before coming into contact with the adhesive

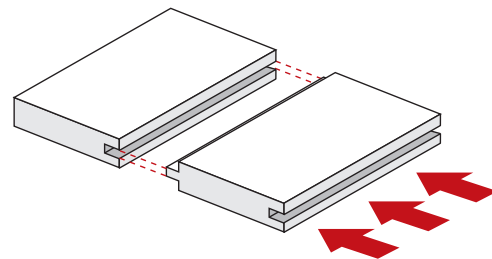
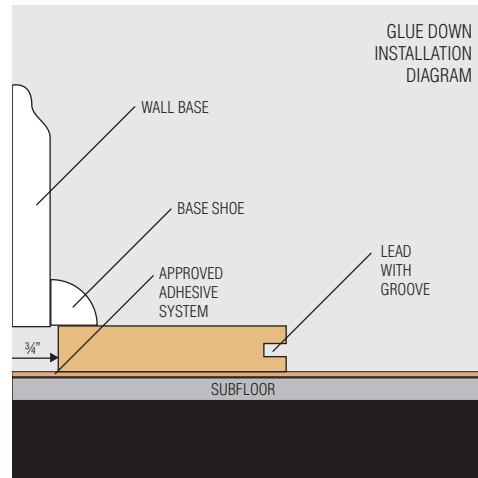

## 13 GD. Starter Rows

Measure the equivalent of four to five rows, mark sub floor at both ends of run and snap a chalk line. Spread adhesive to chalk line. Repeat this process on all subsequent rows of material throughout the balance of installation.

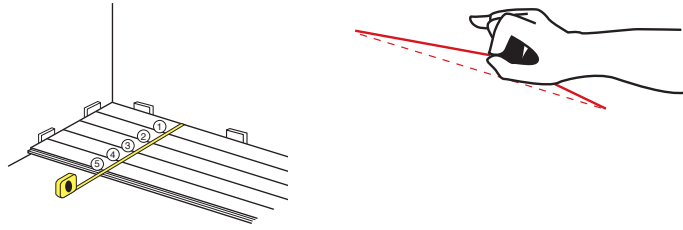

*NOTE: It may be necessary to use painter's tape for delicate surfaces during the install to keep planks together, while glue dries. Remove delicate surface painter's tape within 24 hours of application.*

## 14 GD. Strap Starter Rows

Once starter rows are installed up to chalk line/edge of adhesive bed, strap across the grain. Allow adhesive to set up long enough to have a firm hold. Use the flat side of the trowel to flatten any adhesive at edge of the leading board. Once the boards are firmly seated, proceed to work across the floor.

*CAUTION: Do not let boards open or drift off straight line.*

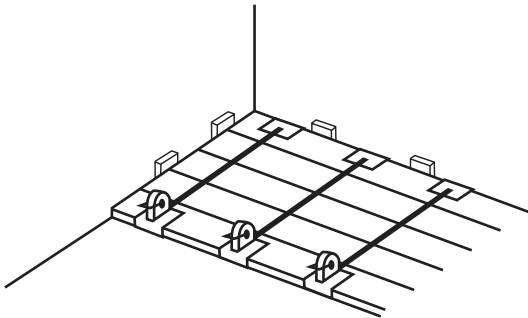

## 15 GD. Check Straight Lines

Run string along joint lines to check in you are wandering off line and use caution to keep all end and side joints closed. The edge of a 6' level or straight edge along the leading rows can also help determine the maintenance of a straight line.

## 16 GD. Trim Last Row

Cut the last row and snug into place using a pull tool. Face nail with 18-gauge nails at edge of last row.

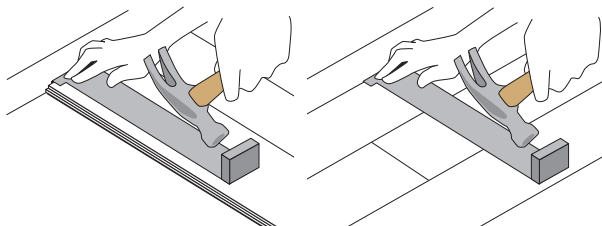

## 17 GD. Install Transition Moldings

Install moldings using urethane glue or high-quality adhesive. It may be necessary to place weight on edge to ensure molding level is flush with flooring.

## Nail Down Installation

### GENERAL INFORMATION

*NOTE: Follow instructions 1-11 and all directions listed below.*

### Installation Tools NAIL DOWN

Tape measure, pencil, chalk line, table saw, cut-off saw, jamb saw, tapping block, pull bar, spacers, hammer, safety glasses, hearing protection, utility knife, wall spacers, straight edge, broom, speedy square, hardwood floor cleaner, pin/finish nails, air compressor, and shop vacuum.

### GENERAL INFORMATION

*NOTE: Follow instructions 1-11 and all directions listed below.*

### Approved Nail/Staple Systems

#### POWER NAIL AIR DRIVEN MODEL 50P

Flex 18 gauge, Cleat 1 1/2".

Use 12 oz. rubber hammer to activate gun.

Gun adjusts to nail 3/8", 7/16", 1/2", 9/16", 5/8"

#### PORTA NAIL AIR DRIVEN MODEL 461A

18 gauge staple, 1/4" crown x 1 1/2" Leg.

Trigger activated.

Gun adjusts to nail 3/8", 7/16", 1/2", 9/16" & 5/8"

#### BOSTITCH AIR DRIVEN MODEL EHF1838K

18 gauge staple, 1/4" crown x 1 1/2" Leg.

Trigger activated.

Gun adjusts to nail 3/8", 7/16", 9/16", & 5/8"

Not approved for installing 3/8"

#### PRIMATECH AIR DRIVEN MODEL Q550R

Adjustable base plate and surface rollers

18 gauge, L cleat x 1 1/2"

Use 12 oz. rubber hammer to activate gun.

Adjusts to nail 3/8", 7/16", 1/2", 9/16", & 5/8"

#### PRIMATECH AIR DRIVEN MODEL 180

Adjustable base plate and surface rollers

18 gauge staple, 1/4" crown

Trigger activated

Gun adjusts to 3/8", 7/16", 1/2" 9/16", 5/8"

#### POWER NAIL AIR DRIVEN MODEL 200

20-gauge/e-cleat 1 1/2".

Use 12-oz. rubber hammer to activate gun.

Gun adjusts to nail 3/8", 1/2", 9/16", & 5/8"

#### HIGHPRO AIR DRIVEN MODEL 4590T

18 gauge staple, 1/4" crown x 1 1/2" Leg.

Trigger activated.

Gun adjusts to nail 3/8", 7/16", 1/2", 9/16" & 5/8"

**DO NOT USE THE FOLLOWING FASTENER SYSTEMS FOR HALLMARK ENGINEERED FLOORS**

STANLEY BOSTITCH MARK III AIR DRIVEN MIIIFS or POWERNAIL MODEL 445 FS HARDWOOD FLOORING STAPLER 15.5 gauge x 2" staple. This fastener gauge is too heavy, and can easily break the tongue, fracture the veneer glue line, weaken the plywood structure, and/or potentially create ply separation and small bumps on the surface of the plank above the fastener.

STANLEY BOSTITCH Model LHF2025K Floor Runner is not appropriate for installation of Hallmark Floors hardwood floors. The fastener is too short (only 1").

POWER NAIL MODEL 2000 is not appropriate for installation of Hallmark engineered hardwood flooring. The maximum fastener is only 1 1/4" - cleat is not long enough.

ONLY USE RECOMMENDED FASTENER SYSTEMS APPROVED IN THESE INSTRUCTIONS!

## 12 ND. Underlayment

### RECOMMENDED UNDERLAYMENTS

15 to 30 lb. roofing felt when doing a nail-down installation. Staple in place and then proceed to install the floor.

Aquabar "B" Hardwood Floor & Tile Underlayment. Staple in place and then proceed to install the floor.

Allglobe -Silicone Vapor Shield. Staple in place and then proceed to install the floor.

### CAUTION:

*Red Rosin or craft paper is not an accepted underlayment. Foam underlayment pads are not acceptable for nail down. Elimination of underlayments in favor of running beads of construction adhesive to increase the holding power to the sub floor has some risks. Underlayments have always acted as a vapor inhibitor. Without the underlayment, the floor is subject to cupping and crowning from moisture intrusion from the sub floor.*

## 13 ND. Starter Rows

Nail-down method requires that installation be done by leading with the tongue. When starting at the wall, trim groove off the back of the boards being used for the starting row. Face nail the back edge of the board with 18-gauge nails, then blind nail into the pocket above the tongue with one of the above approved nail/staple systems.

As face nailing is accepted practice, face nailing the boards as far back as possible can help hide the face nailing under the base and quarter round/base shoe. It may be necessary to blind nail the tongues of the starter boards to eliminate any surface nail holes until far enough from the wall to use floor nailer.

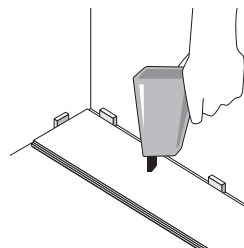
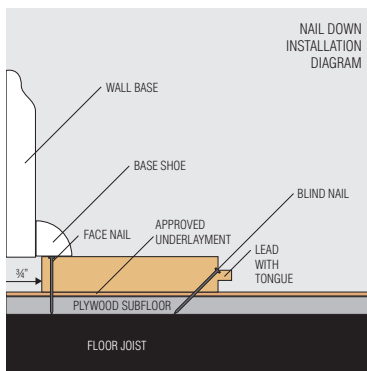

## 14 ND. Nail/Staple Spacing

Nail/staple spacing needs to be 4" to 6" apart and within 2" of board ends. Installer should be standing directly on top of the board being nailed down. This ensures the bottom of the plank is firmly seated on the sub floor. Check regularly to ensure the plank is snug to the sub floor. Any gap between the bottom of the plank and the sub floor is a source for squeaking.

*Warning: Nailing too close to end could fracture the corner of the plank.*

## 15 ND. Check Straight Line

After three rows of flooring have been installed, take a six-foot level and check the leading edge to be sure floor is on a straight line. Lay the level on its back and glide bottom edge along the tongue. Failure to stay on a straight line will cause irregular gaps in floor on sides and ends.

## 16 ND. Trim & Face Nail End Rows

Cut the last row and snug into place using a pull tool. Face nail the remaining rows with 18 gauge nails. It will be necessary to face nail the remaining rows when the blind nail fun is too close to the wall to fasten down the planks.

# Floating Installation

### GENERAL INFORMATION

*NOTE: Follow instructions 1-11 and all directions listed below.*

### Installation Tools FLOAT

Tape measure, pencil, chalk line, table saw, cut-off saw, jamb saw, tapping block, pull bar, spacers, hammer, safety glasses, hearing protection, utility knife, wall spacers, straight edge, broom, speedy square, hardwood floor cleaner, and shop vacuum.

## 12 FL. Underlayment

Eternity Premium Underlayment pad or comparable is recommended. Follow pad manufacturer's installation instructions. Always use a high quality, firm underlayment pad with a built-in moisture membrane.

### 13 FL. Lead with Groove

Cut off tongue on very first row to be installed and lead with the groove. This enables the tongue to be partially inserted into groove before coming into contact with the underlayment. Place a bead of white PVA / D3 rated tongue and groove glue into the bottom of the groove.

### 14 FL. Use Tapping Block

When tapping floor together with block start tapping from lead end and work back towards where the two end joints are coming together. Tapping back towards the floor tightens the end-joint.

### 15 FL. Tape/Strap Starter Rows

After three rows of flooring have been installed, take a 6' level and check the leading edge to be sure floor is on a straight line. Lay the level on its back and glide bottom edge along the tongue. Failure to stay on a straight line will cause irregular gaps in floor on sides and ends.

**NOTE:** It may be necessary to use painter's tape for delicate surfaces during the install to keep planks together. Remove delicate surface painter's tape within 24 hours of application.

### 16 FL. Check Straight Line

Run string along joint lines to check in you are wandering off line and use caution to keep all end and side joints closed. The edge of a 6' level or straight edge along the leading rows can also help determine the maintenance of a straight line.

### 17 FL. Trim Last Row

Trim last row to fit and pull into place with pull tool. Tape last several rows in place to prevent accidental movement and opening of side joints.

### 18 FL. Install Lip/Over Transition Moldings

**CAUTION:** Do not attach lip/over moldings directly to the edge of the floor. Fasten transition lip/over moldings to the sub floor only. Attaching the lip/over to the edge of the floor prohibits the free movement of the floor.

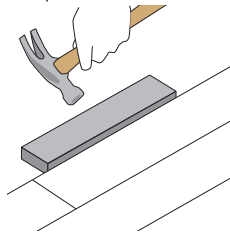
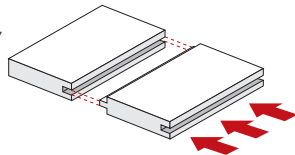

## Clean Up

- A. Clean up any adhesive or glue residue immediately. If glue or adhesive is allowed to dry on the floor's surface, it can damage the finish when it is removed.
- B. Completely remove any delicate surfaces painter's tape (never use masking tape) within 24 hours of application. If direct sunlight is hitting tape, it must be removed within 12 hours.
- C. Adhesive residue, glue residue, and shoe marks can be removed with mineral spirits.  
  
NuOil®: Follow immediately with NuOil® Natural Oil Cleaner to remove any mineral spirit residue.  
  
TrueMark Poly/Glaze Tek® Finish: Follow immediately with TrueClean® Floor Cleaner to remove mineral spirit residue.
- D. Remove dust and dirt regularly during installation and upon completion with a soft brush attachment on a shop vacuum.
- E. Move refrigerators with a soft wheel dolly or glides to avoid denting floor. Do not install stiff copper tubing from water source to ice maker. Use flexible braid tubing instead. A braided hose is much more durable and less prone to leak.

*For flooring touch up and scratch repair, refer to Hallmark Floors Total Floor Care Hardwood Floor Touch Up Guide.*

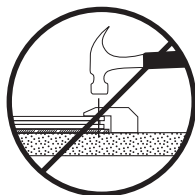





V1 2016

2360 S. Archibald Ave.  
Ontario, CA 91761

ff 888.551.0888

p 909.947.7736

f 909.947.7776

[www.hallmarkfloors.com](http://www.hallmarkfloors.com)

[claims@hallmarkfloors.com](mailto:claims@hallmarkfloors.com)